

VERTIKALSCHNITT

**KT-ATT 02**

Attikaprofil

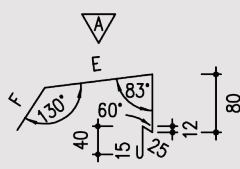

Zuschnitt: s.Tab.mm

KT-ATT 02/+ Kennzahl							
Dämmstoffdicke	40	50	60	80	100	120	
Kennzahl	4	5	6	8	10	12	
E	100	110	120	140	160	180	
F	45	35	126	106	86	106	
Z	305	305	406	406	406	436	

**KT-ATT 05**

Attikagrundprofil  
verzinkt

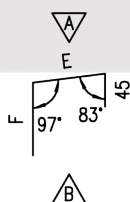

Zuschnitt: s.Tab.mm

KT-ATT 05/+ Kennzahl							
Dämmstoffdicke	40	50	60	80	100	120	
Kennzahl	4	5	6	8	10	12	
E	42	52	62	82	102	122	
F	116	106	96	76	97	77	
Z	203	203	203	203	244	244	

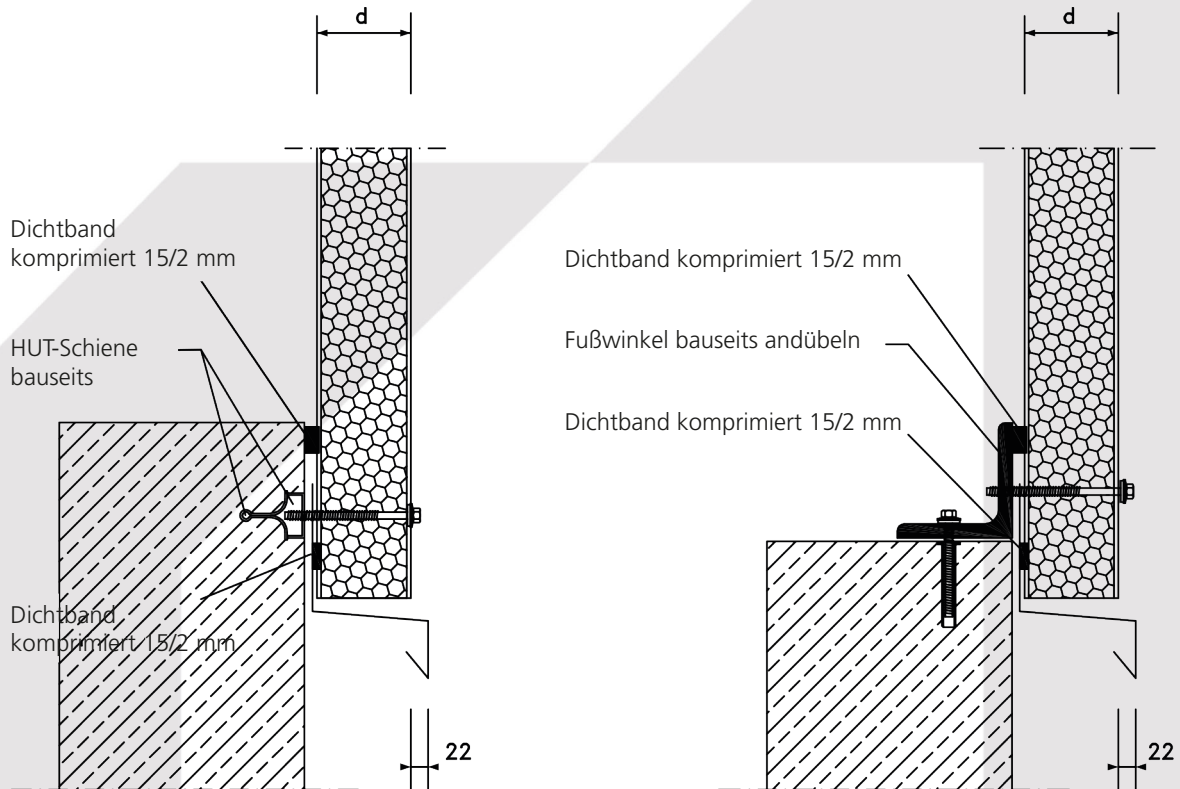

VERTIKALSCHNITT

Änderungen vorbehalten \* Stand August 2020

KT-SOC 02

Tropfprofil

Zuschnitt: s.Tab.mm

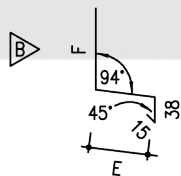

KT-SOC 02/+ Kennzahl						
Dämmstoffdicke	40	50	60	80	100	120
Kennzahl	4	5	6	8	10	12
E	62	72	82	102	122	142
F	88	78	109	89	130	110
Z	203	203	244	244	305	305

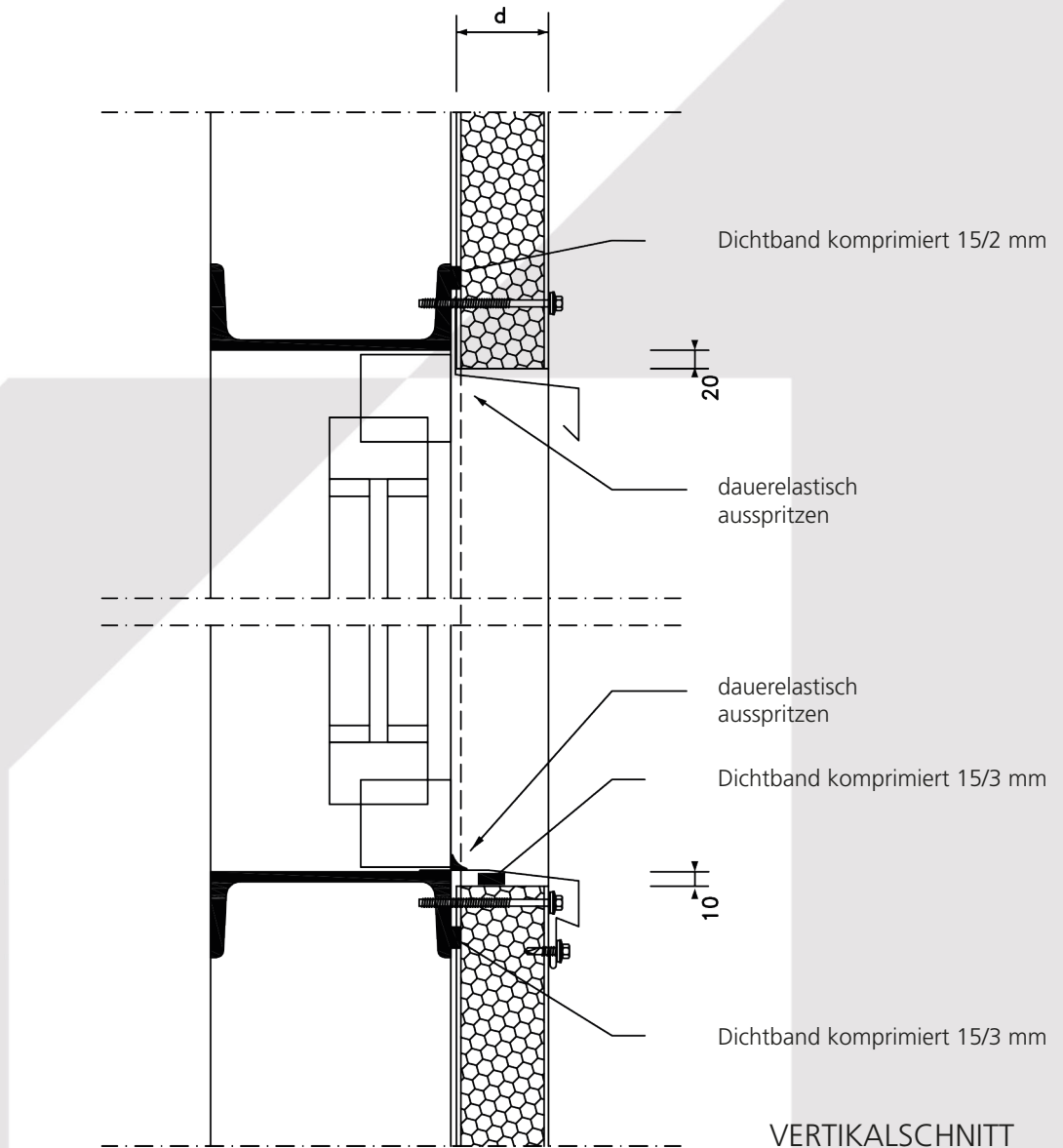

Änderungen vorbehalten \* Stand August 2020

**KT-WOE 08**

Sturzprofil

Zuschnitt: s.Tab.mm

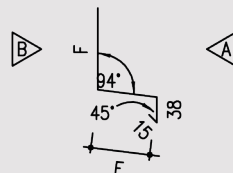

KT-WOE 08/+ Kennzahl						
Dämmstoffdicke	40	50	60	80	100	120
Kennzahl	4	5	6	8	10	12
E	62	72	82	102	122	142
F	88	78	109	89	130	110
Z	203	203	244	244	305	305

**KT-WOE 02**

Fensterbankprofil

Zuschnitt: s.Tab.mm

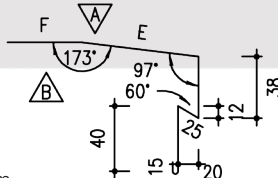

KT-WOE 02/+ Kennzahl						
Dämmstoffdicke	40	50	60	80	100	120
Kennzahl	4	5	6	8	10	12
E	60	70	80	100	120	140
F	66	56	46	26	67	47
Z	244	244	244	244	305	305

Zu bevorzugen

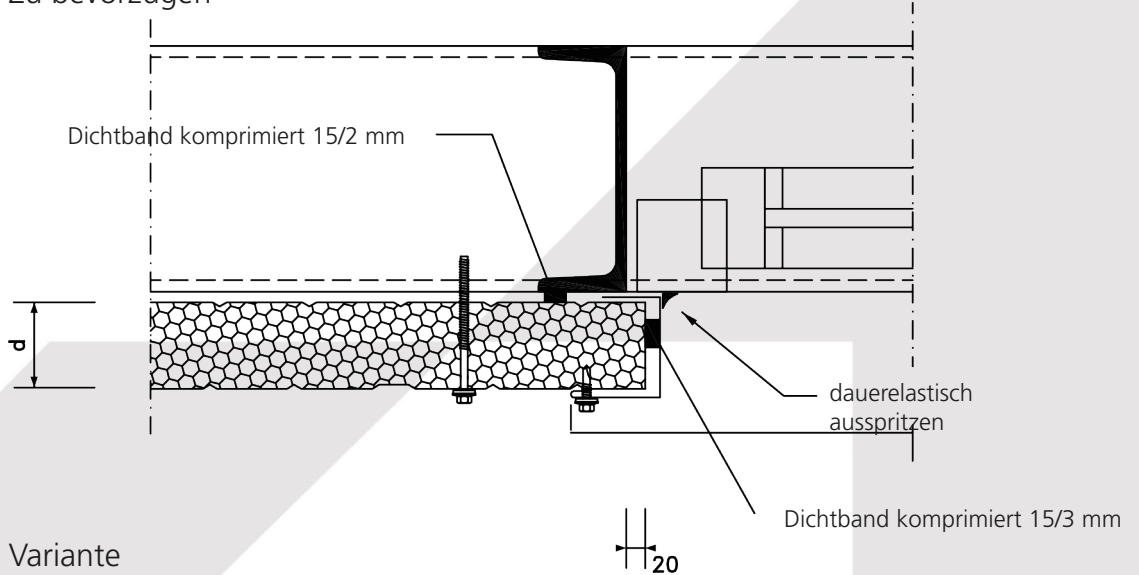

Variante

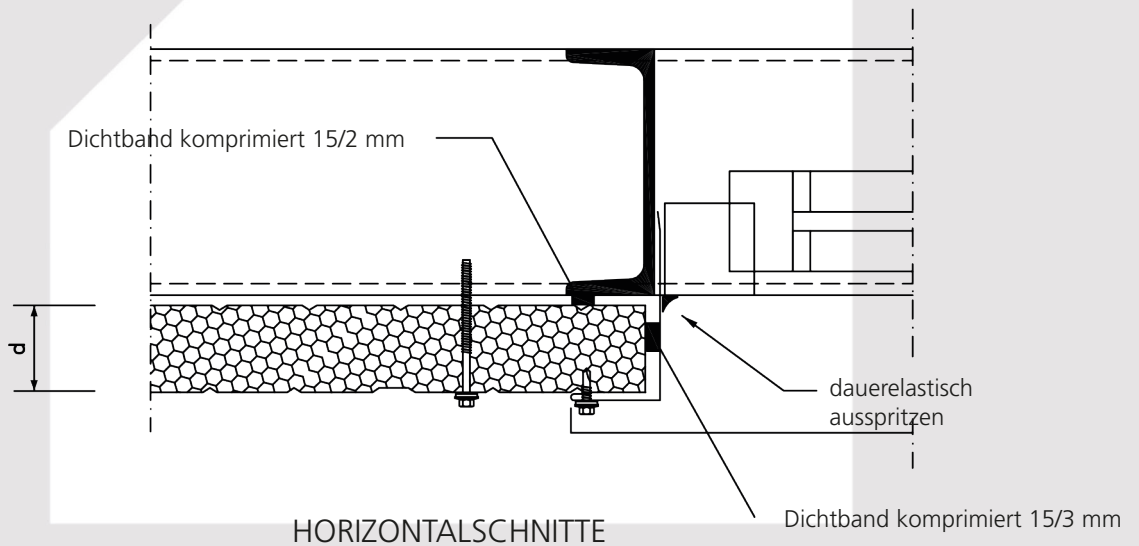

HORIZONTALSCHNITTE

KT-WOE 11

U-Einlassprofil  
Zuschnitt: s. Tab. mm

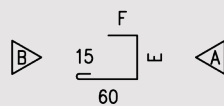

KT-WOE 11/+ Kennzahl

Dämmstoffdicke	40	50	60	80	100	120
Kennzahl	4	5	6	8	10	12
E	43	53	63	83	103	123
F	34	46	36	45	66	46
Z	152	174	174	203	244	244

KT-WOE 14

L-Einlassprofil  
Zuschnitt: s. Tab. mm

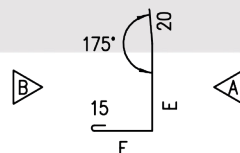

KT-WOE 14/+ Kennzahl

Dämmstoffdicke	40	50	60	80	100	120
Kennzahl	4	5	6	8	10	12
E	108	118	149	149	149	149
F	-	-	-	-	-	-
Z	203	203	244	244	244	244

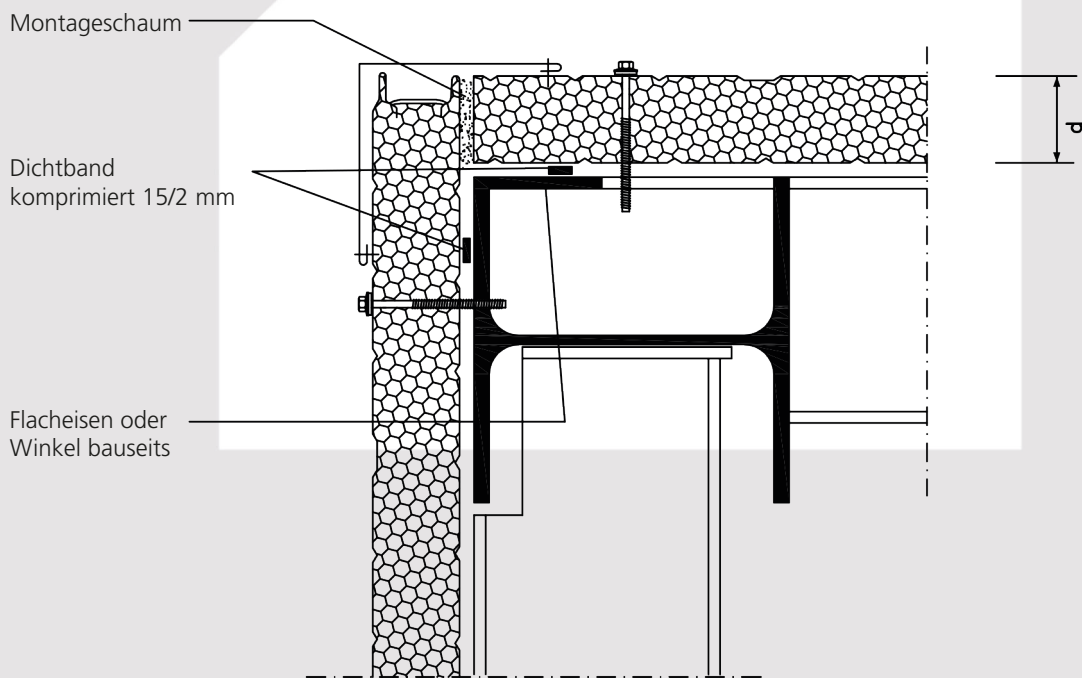
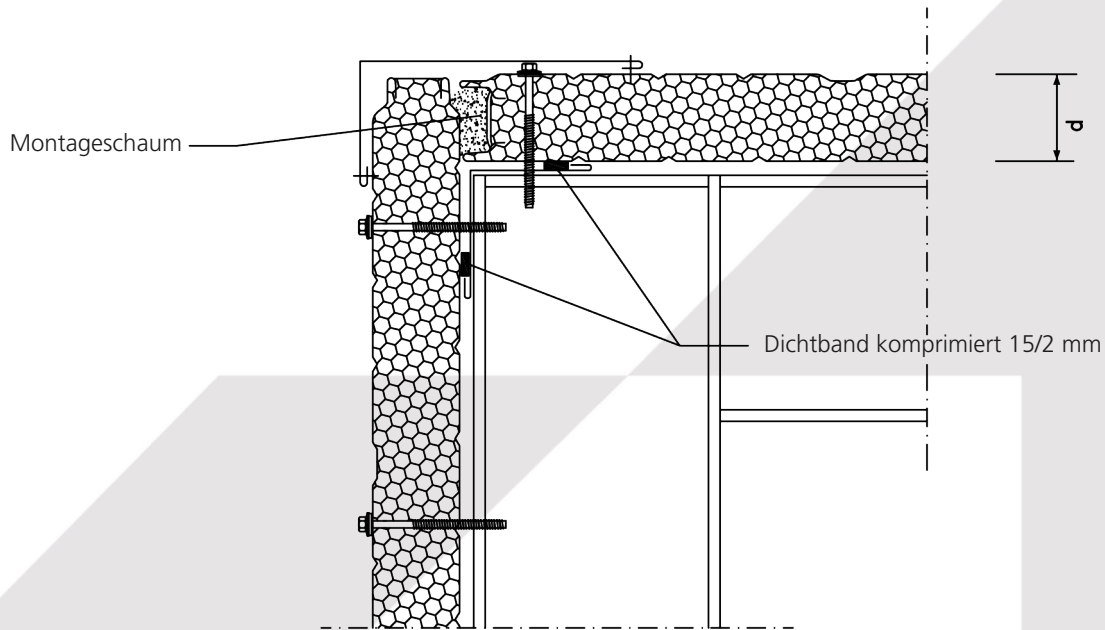

HORIZONTALSCHNITTE

Änderungen vorbehalten \* Stand August 2020

KT-AUS 03

Außeneckprofil

Zuschnitt: 305 mm

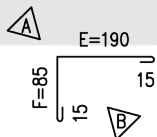

KT-AUS 04

Außeneckprofil

Zuschnitt: 305 mm

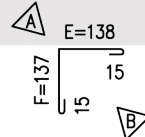

KT-AUS 14

Inneneckwinkel

Zuschnitt: 203 mm

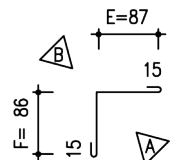

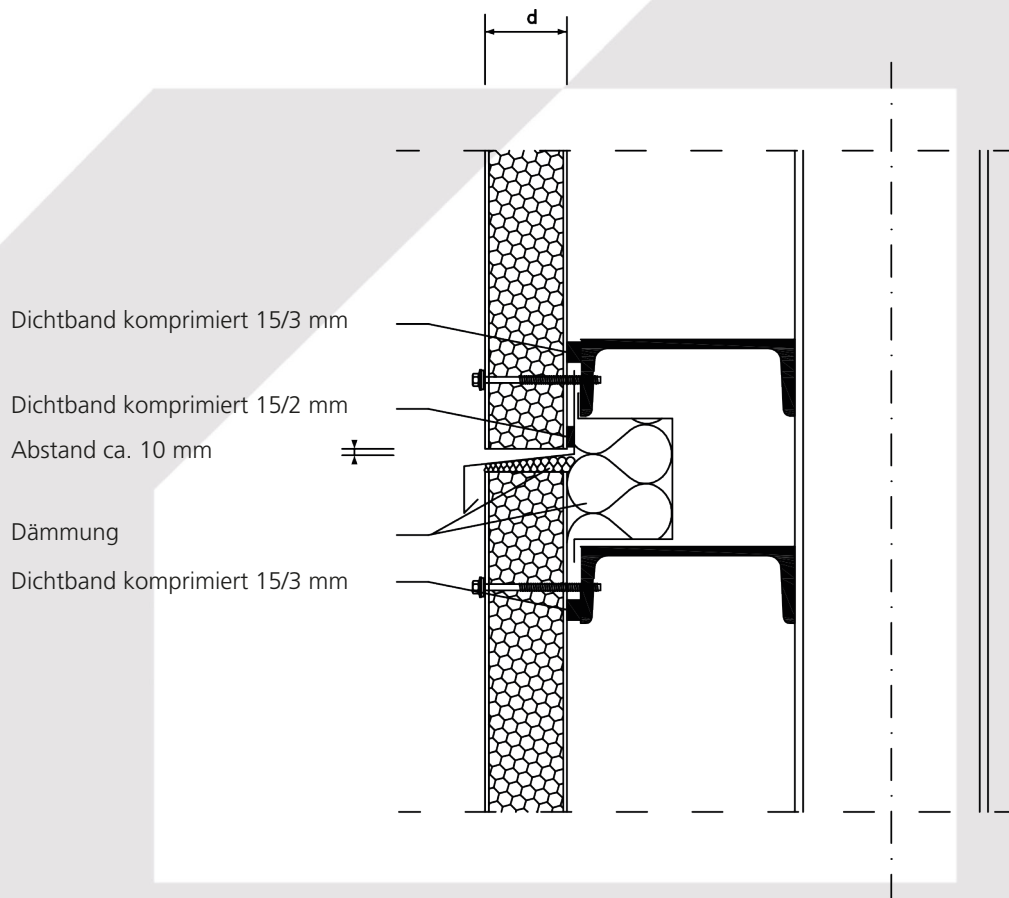

Änderungen vorbehalten \* Stand August 2020

KT-SOC 02

Tropfprofil

Zuschnitt: s.Tab.mm

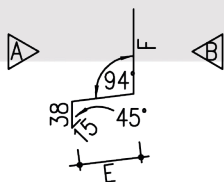

KT-SOC 02/+ Kennzahl						
Dämmstoffdicke	40	50	60	80	100	120
Kennzahl	4	5	6	8	10	12
E	62	72	82	102	122	142
F	88	78	109	89	130	110
Z	203	203	244	244	305	305